

Absperrklappe Typ 1170
 Vanne papillon type 1170
 Butterfly valve type 1170

5.3.00



DN 250–900



/
/
/
/
/
/

	Standard-Ausführung/exécution standard/ standard construction	Option
Gehäuse/corps/body:	Doppelflansch EN-JL1040/à brides EN-JL1040/ double flanged Cast Iron	EN-JL1082/ Ductile Iron
Klappenscheibe/papillon/disc:	zentrisch EN-JS1082, Rilsan/centrique EN-JS1082, Rilsan/ centric Ductile Iron, Rilsan	1.4401/316SS
Welle/arbre/shaft:	1.4021	
Dichtung/joint/seal:	EPDM	NBR, FPM
Korrosionsschutz/protection anti- corrosion/corrosion protection:	Epoxid-Kunststoffbeschichtung EKB/ revêtement époxy/epoxy powder coat	
Flanschbohrung/perçage des brides/flange drilling:	PN 10	
Baulänge/Dimension face à face selon/face-to-face:	EN 558-1 Reihe 20/série 20/series 20 (DIN 3202 K1)	
Betriebsdruck/pression de service/nominal pressure:	10 bar	
Prüfung nach/Essais selon/ Test acc.	EN-12266-1, Rate A/taux A/rate A	
Antriebe/actionnement/actuator:	Getriebe mit Handrad/réducteur avec volant/gear with handwheel Pneumatiktrieb/actionneur pneumatique/pneumatic actuator Elektroantrieb/actionneur électrique/electric actuator	

Andere Werkstoffe und Druckstufe PN 16 auf Anfrage
 Autres matériaux et pression PN16 sur demande
 For other materials and nominal pressure PN16 refer to factory

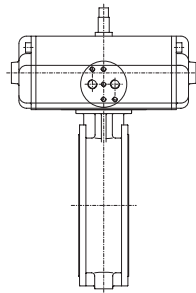
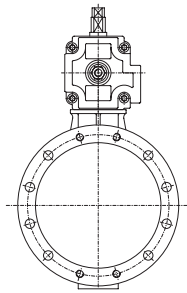

1170-6 mit Pneumatiktrieb/avec actionneur pneumatique/with pneumatic actuator

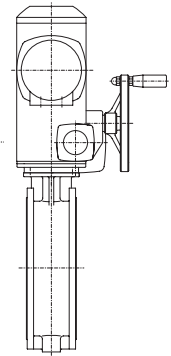
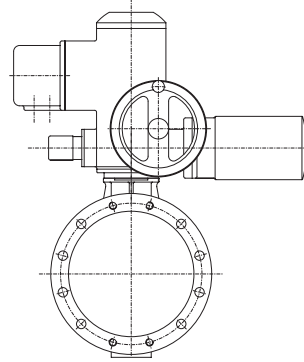

1170-7 mit Elektroantrieb/avec actionneur électrique/with electric actuator

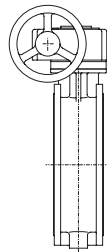
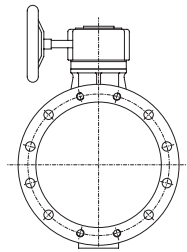

1170-4 mit Getriebe/avec réducteur/with worm gear

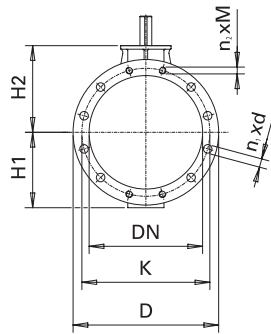

DN	D	K	H1	H2	C	n ₁	d	PN 10 n ₂	M	Gewicht Poids Weight (kg)
250	400	350	207	245	68	12	22	-	-	31
300	455	400	243	282	78	12	22	-	-	41
350	515	460	300	318	92	12	22	4	M20	56
400	575	515	326	362	102	12	26	4	M24	109
450	635	565	364	410	114	12	26	8	M24	144
500	710	620	408	435	127	12	26	8	M24	185
600	835	725	482	519	154	12	30	8	M27	261
700	905	840	564	548	165	24	30	-	-	352
800	1020	950	608	587	190	24	33	-	-	448
900	1115	1050	655	661	203	28	33	-	-	585